

This drawing and design is protected by copyright and the information is confidential. It is also protected and registered under Dutch laws through the Dutch government department for taxes. The drawing and/or models may not be copied, reproduced, duplicated or disclosed to others, in whole or in part without prior written consent of Rob Snel B.V./the Netherlands

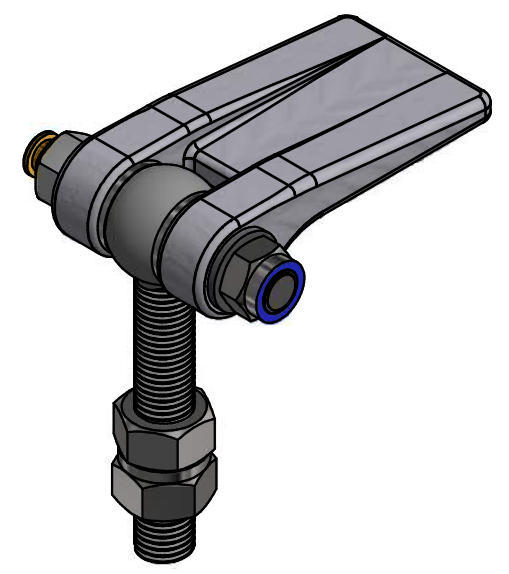

3D-IMPRESSION - EXPLODED VIEW

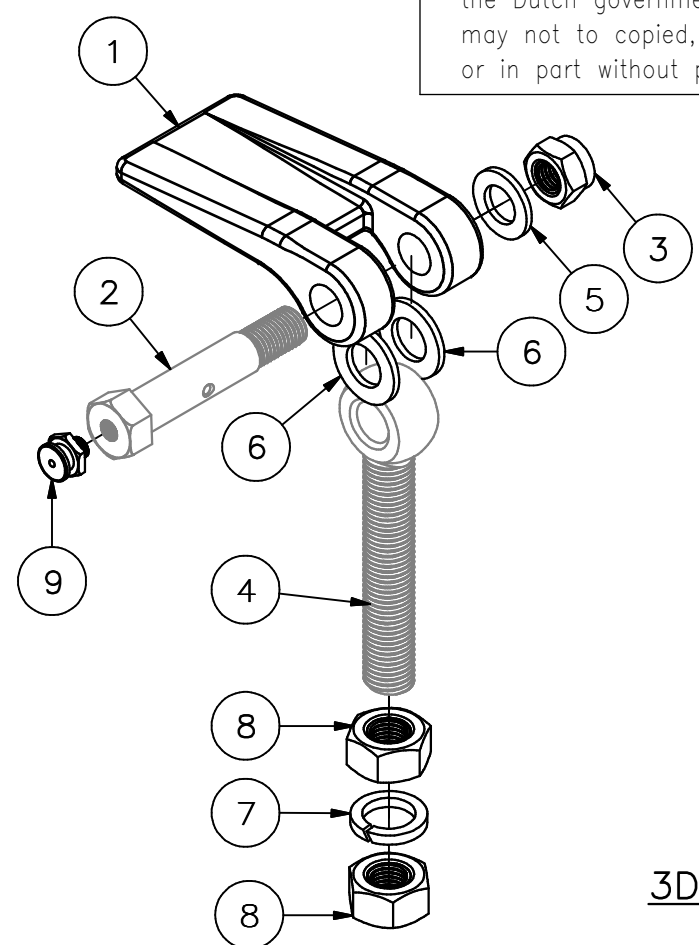
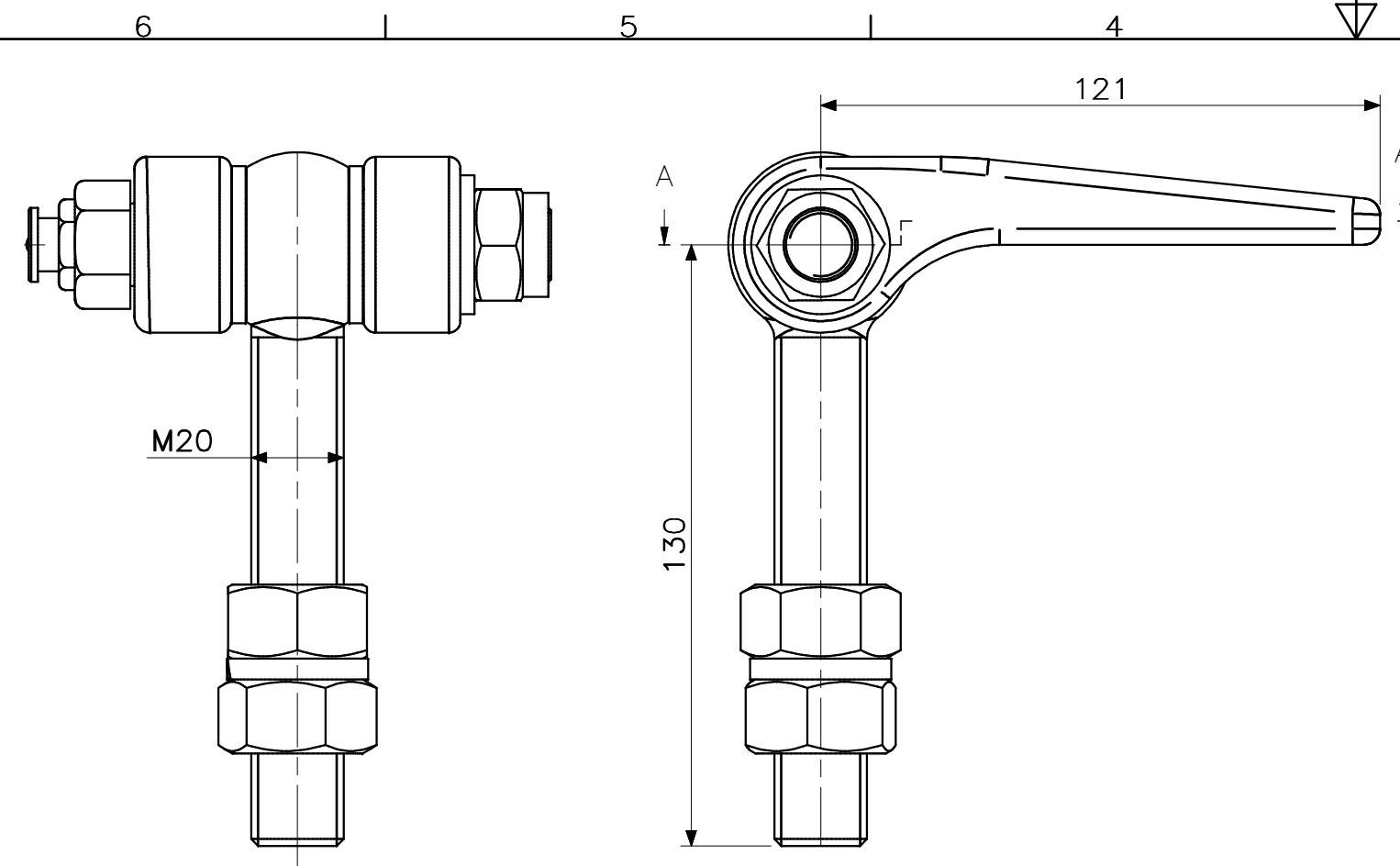
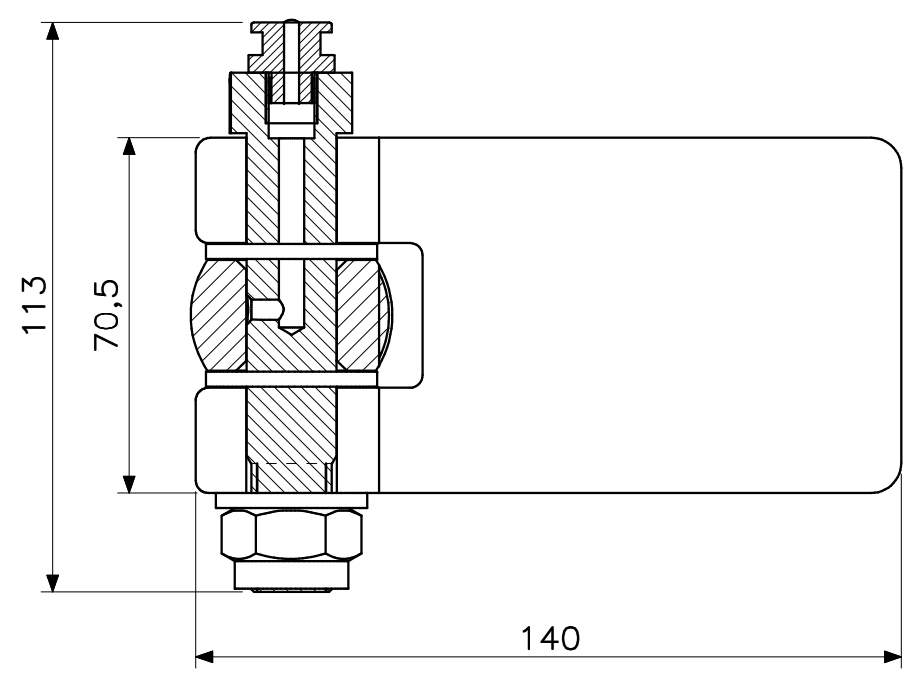

POS	QTY	TITLE	MATERIAL	DIMENSION	DWG NR
9	1	Grease nipple	Messing	1/8 BSP	80.BR.412.01
8	2	HEX NUT M20	Stainless Steel	DIN 934 - M20	20.SS.910.14
7	1	Spring Washer M20	Stainless Steel	M20	20.SS.922.14
6	2	Washer M18	Stainless Steel	M18	16.SS.920.18
5	1	Washer M16	Galvanised	M16	16.ST.920.23
4	1	EYE BOLT M20x130 STAINLESS STEEL	Stainless Steel	M20	20.SS.310.27
3	1	LOCK NUT DIN985	Galvanised	DIN 958 - M16	16.ST.912.23
2		BOLTSPINDLE M16 STAINLESS STEEL	Stainless Steel	L:103mm	16.SS.310.05
1	1	Aluminium CT Hinge	Aluminum	L:103mm	20.AL.306.01

C		
B		
A		

Rev.: REV. DATE: REVISION SUBJECT

Date:	10-6-2022	 <p>Rob Snel Technische Groothandel Industrieweg 39 3361 HJ Sliedrecht</p> <p>T +31 (0)184 43 30 30 F +31 (0)184 43 30 31 E s.snel@robsnel.nl I www.robsnel.nl</p>	Art.nr:
Drawn:	Hans Baars		Projection type:
Scale:	1:1,5		
Status:	Pending		
Cust.:			
Project:			

Title: Assembly M20 Hinges set

Mat:	Dwg.nr:	Revision:	Sheet:	Format:
	20.AL.390.73		1	A3